

LADDER

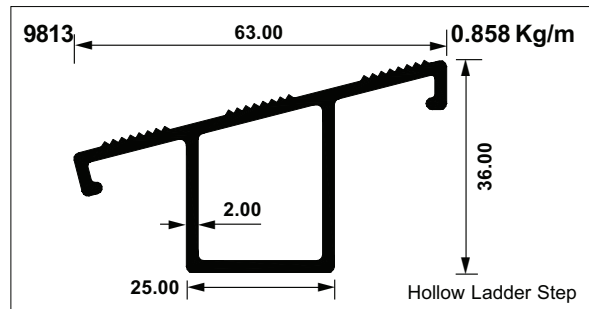

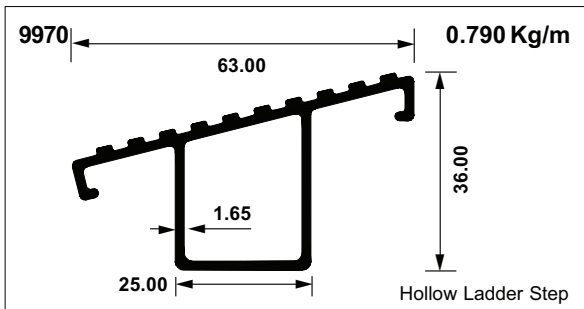
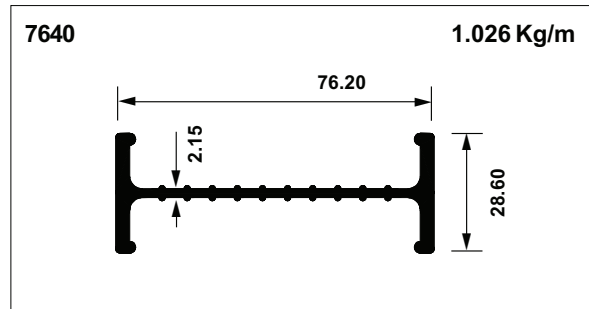
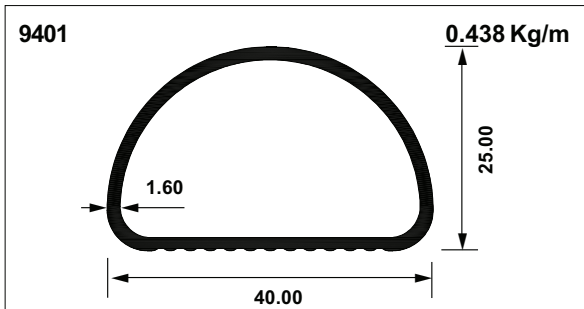
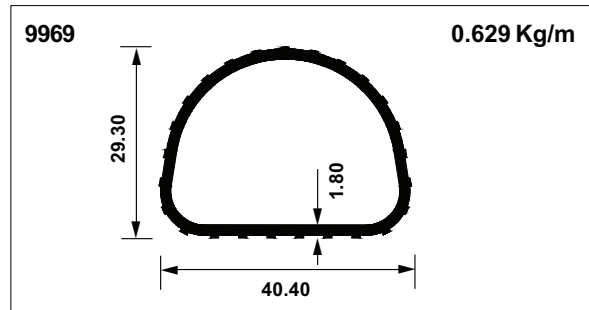
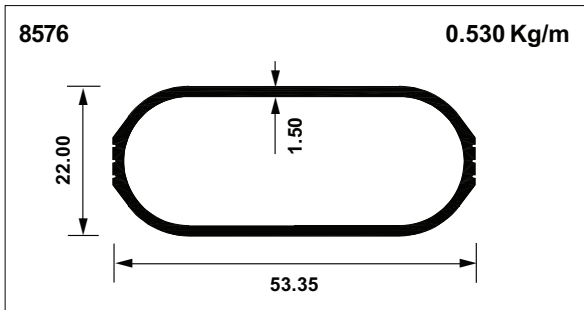
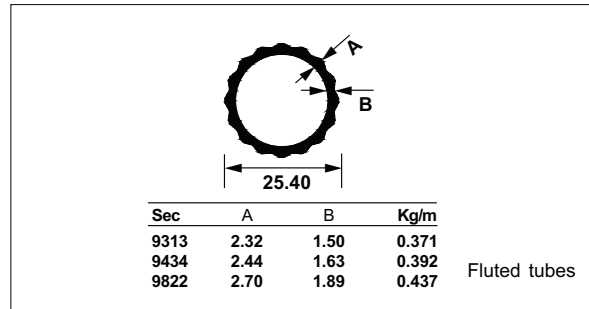
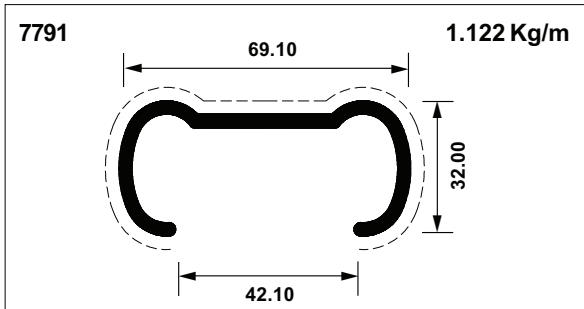
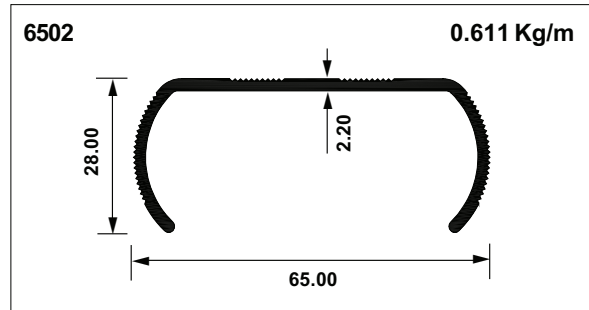
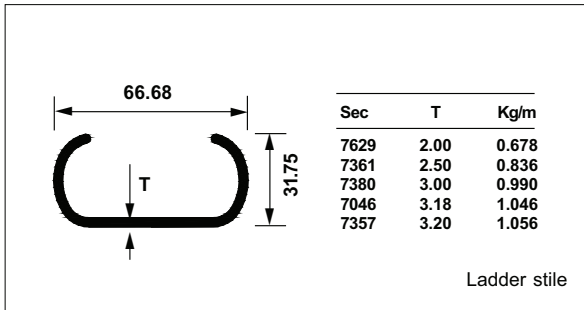
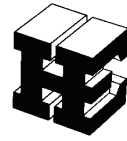
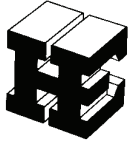

LADDER

9842

1.222 Kg/m

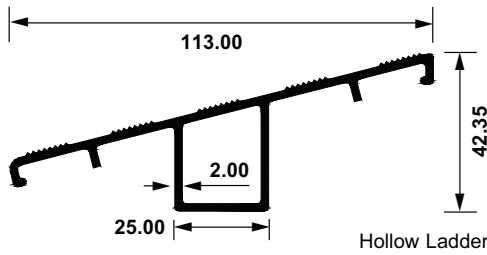

Hollow Ladder Step

8614

0.521 Kg/m

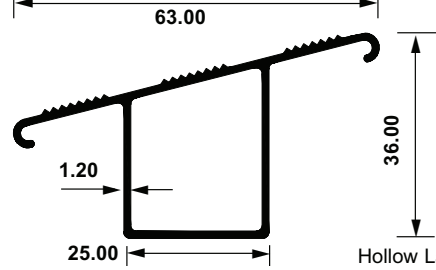

Hollow Ladder Step

6602

0.562 Kg/m

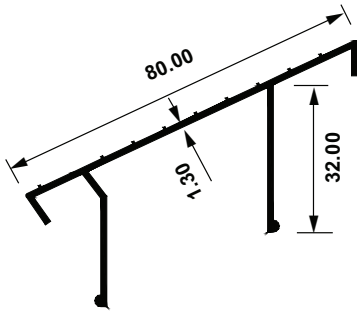

6638

1.945 Kg/m

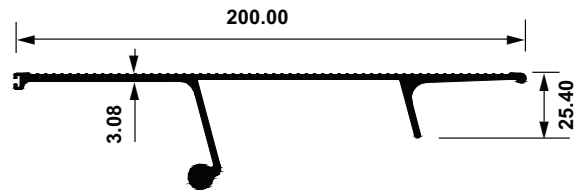

Ladder Top

6739

0.447 Kg/m

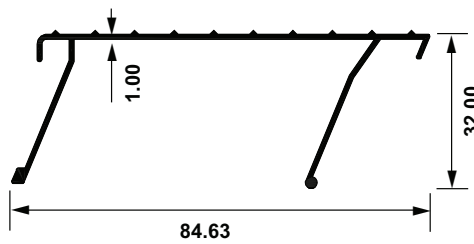

6703

0.525 Kg/m

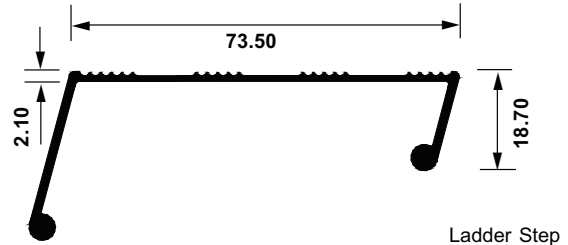

Ladder Step

6497

0.594 Kg/m

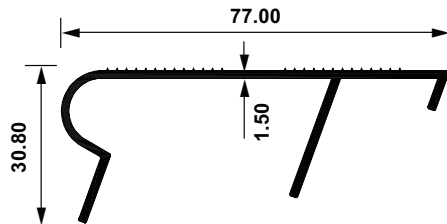

6541

0.399 Kg/m

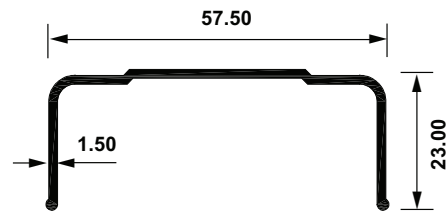

6542

0.381 Kg/m

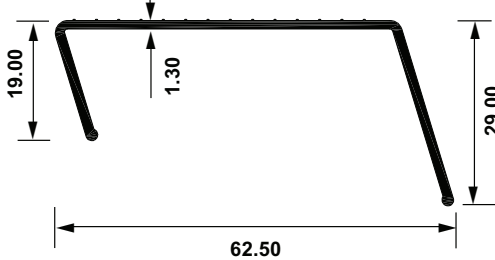

6543

1.010 Kg/m

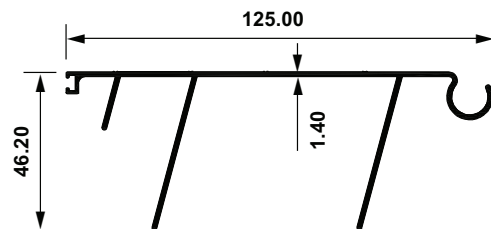

LADDER

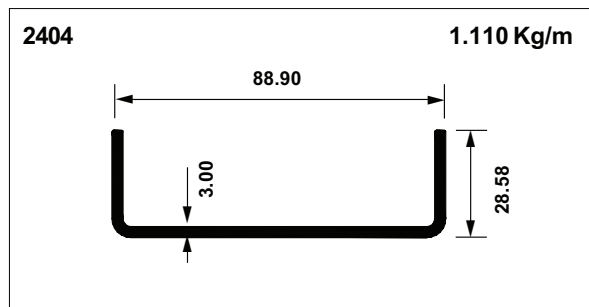
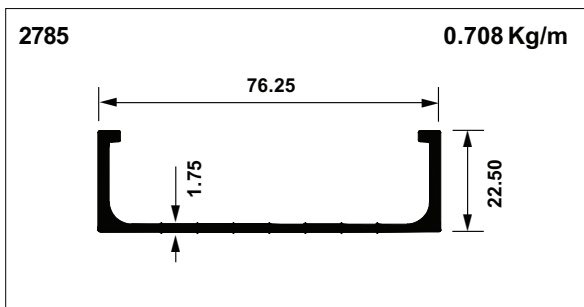
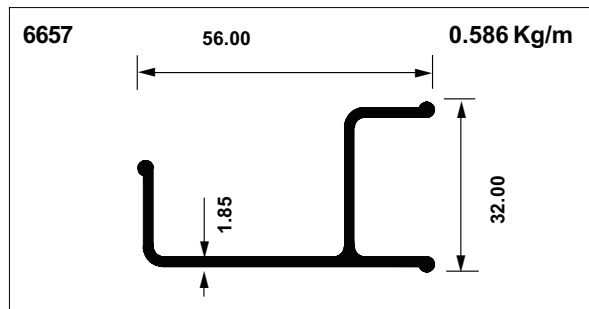
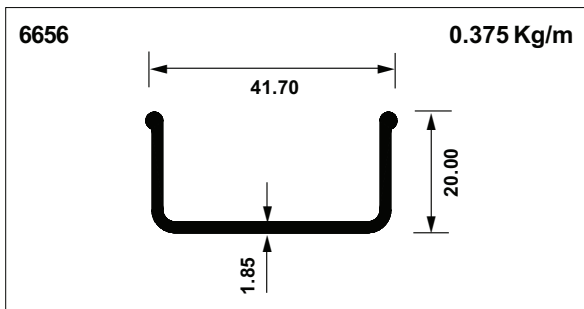
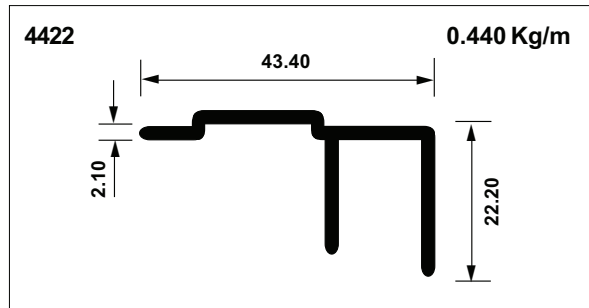
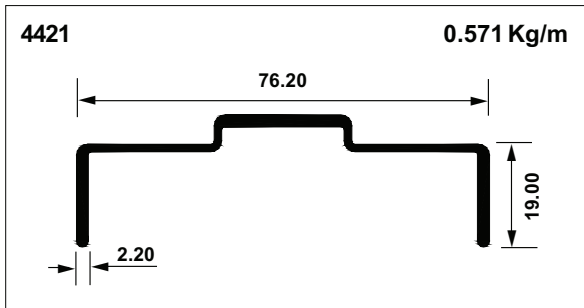
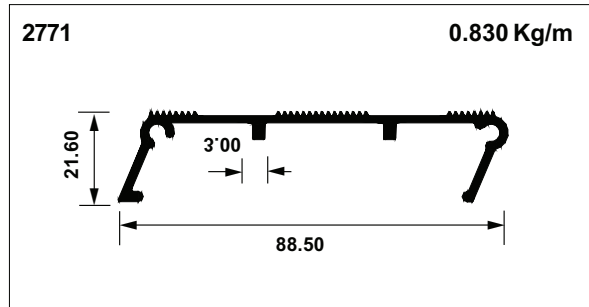
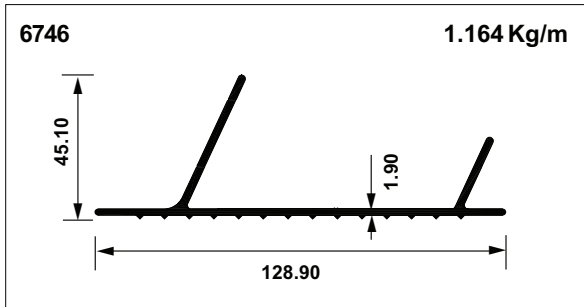
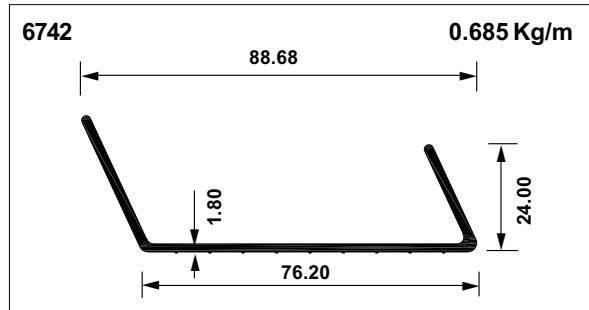
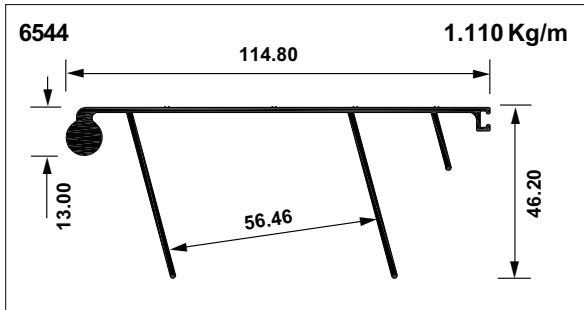
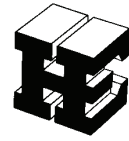

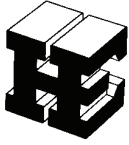

LADDER

7240

0.925 Kg/m

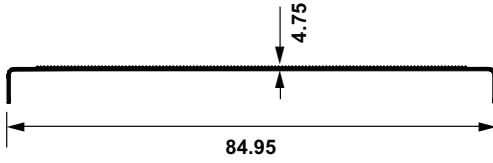

6741

0.562 Kg/m

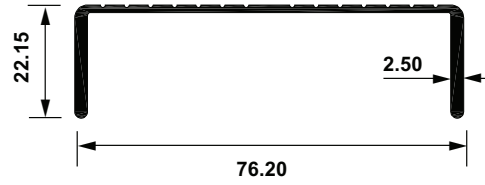

6509

1.175 Kg/m

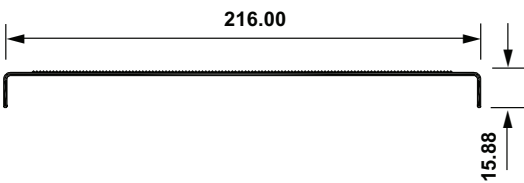

7838

0.550 Kg/m

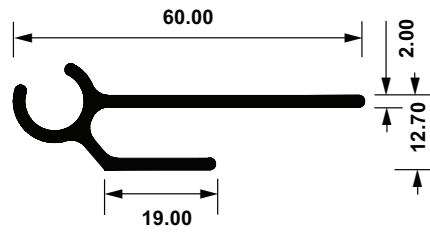

7837

1.570 Kg/m

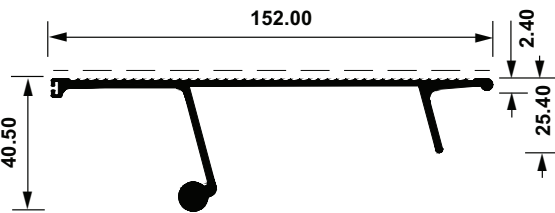

7843

0.580 Kg/m

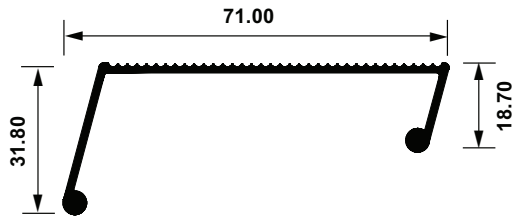

7840

0.640 Kg/m

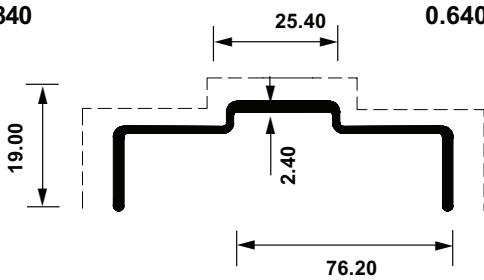

7839

0.294 Kg/m

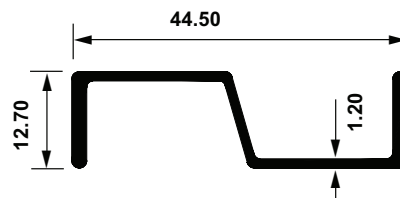

8537

1.286 Kg/m

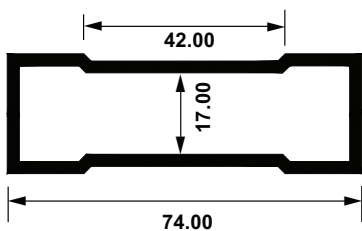

8538

0.702 Kg/m

